

YAMAHA RX-750/550

80W + 80W (8Ω) RMS Output Power, 0.015% THD, 20–20,000 Hz (RX-750)

60W + 60W (8Ω) RMS Output Power, 0.015% THD, 20–20,000 Hz (RX-550)

40-Station Random Preset Tuning

IF Count Direct PLL Synthesizer Tuning System

Continuously Variable Loudness Control

High Dynamic Power, Low Impedance Drive Capability

Pure Direct Switch

Sleep Timer

Remote Control Capability

Video Signal Input/Output Capability (RX-750 only)

Thank you for selecting the YAMAHA stereo receiver.



OWNER'S MANUAL

CONTENTS

Safety Instructions	2
Caution	3
Warning	3
Supplied Accessories	3
Connections	4
Operations	7
Tuning Operations	9
Remote-Control Transmitter	11
Notes about the Remote Control Transmitter	12
Troubleshooting	12
Specifications	13

IMPORTANT!

Please make a note of the serial number of this unit in the space indicated below.

Model:
Serial No.

The serial number is inscribed on the rear of the unit.
Keep this Owner's Manual in a safe place for future reference.

WARNING

To reduce the risk of fire or electric shock, do not expose this appliance to rain or moisture.

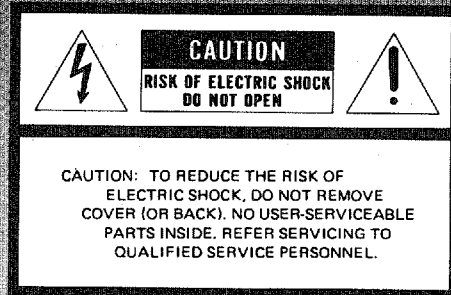

• Explanation of Graphical Symbols



The lightning flash with arrowhead symbol, within an equilateral triangle, is intended to alert you to the presence of uninsulated "dangerous voltage" within the product's enclosure that may be of sufficient magnitude to constitute a risk of electric shock to persons.



The exclamation point within an equilateral triangle is intended to alert you to the presence of important operating and maintenance (servicing) instructions in the literature accompanying the appliance.

SAFETY INSTRUCTIONS

- 1 Read Instructions – All the safety and operating instructions should be read before the appliance is operated.
- 2 Retain Instructions – The safety and operating instructions should be retained for future reference.
- 3 Heed Warnings – All warnings on the appliance and in the operating instructions should be adhered to.
- 4 Follow Instructions – All operating and other instructions should be followed.
- 5 Water and Moisture – The appliance should not be used near water – for example, near a bathtub, washbowl, kitchen sink, laundry tub, in a wet basement, or near a swimming pool, etc.
- 6 Carts and Stands – The appliance should be used only with a cart or stand that is recommended by the manufacturer.



- 6A An appliance and cart combination should be moved with care. Quick stops, excessive force, and uneven surfaces may cause the appliance and cart combination to overturn.
- 7 Wall or Ceiling Mounting – The appliance should be mounted to a wall or ceiling only as recommended by the manufacturer.
- 8 Ventilation – The appliance should be situated so that its location or position does not interfere with its proper ventilation. For example, the appliance should not be situated on a bed, sofa, rug, or similar surface, that may block the ventilation openings; or placed in a built-in installation, such as a bookcase or cabinet that may impede the flow of air through the ventilation openings.
- 9 Heat – The appliance should be situated away from heat sources such as radiators, stoves, or other appliances that produce heat.
- 10 Power Sources – The appliance should be connected to a power supply only of the type described in the operating instructions or as marked on the appliance.
- 11 Power-Cord Protection – Power-supply cords should be routed so that they are not likely to be walked on or pinched by items placed upon or against them, paying particular attention to cords at plugs, convenience receptacles, and the point where they exit from the appliance.
- 12 Cleaning – The appliance should be cleaned only as recommended by the manufacturer.
- 13 Nonuse Periods – The power cord of the appliance should be unplugged from the outlet when left unused for a long period of time.
- 14 Object and Liquid Entry – Care should be taken so that objects do not fall into and liquids are not spilled into the inside of the appliance.
- 15 Damage Requiring Service – The appliance should be serviced by qualified service personnel when:
 - A. The power-supply cord or the plug has been damaged; or
 - B. Objects have fallen, or liquid has been spilled into the appliance; or
 - C. The appliance has been exposed to rain; or
 - D. The appliance does not appear to operate normally or exhibits a marked change in performance; or
 - E. The appliance has been dropped, or the cabinet damaged.

- 16 Servicing – The user should not attempt to service the appliance beyond those means described in the operating instructions. All other servicing should be referred to qualified service personnel.
- 17 Power Lines – An outdoor antenna should be located away from power lines.
- 18 Grounding or Polarization – The precautions that should be taken so that the grounding or polarization is not defeated.
- 19 Outdoor Antenna Grounding – If an outside antenna is connected to this unit, be sure the antenna system is grounded so as to provide some protection against voltage surges and built up static charges. Section 810 of the National Electrical Code, ANSI/NFPA No. 70-1984, provides information with respect to proper grounding of the mast and supporting structure, grounding of the lead-in wire to an antenna discharge unit, size of grounding conductors, location of antenna discharge unit, connection to grounding electrodes, and requirements for the grounding electrode.

EXAMPLE OF ANTENNA GROUNDING

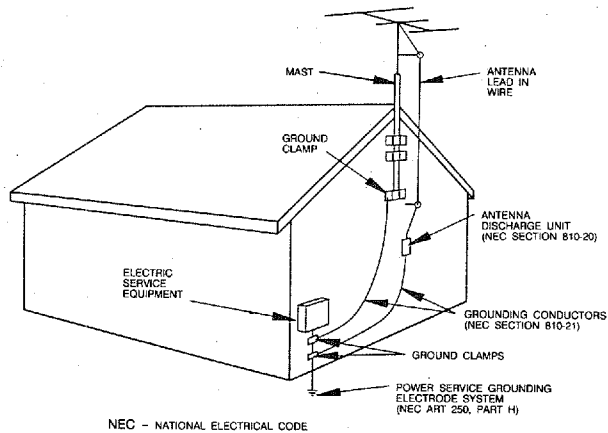

NEC – NATIONAL ELECTRICAL CODE

Note to CATV system installer:

This reminder is provided to call the CATV system installer's attention to Article 820-40 of the NEC that provides guidelines for proper grounding and, in particular, specifies that the cable ground shall be connected to the grounding system of the building, as close to the point of cable entry as practical.

CAUTION: READ THIS BEFORE OPERATING YOUR UNIT

- 1 To ensure the finest performance, please read this manual carefully. Keep it in a safe place for future reference.
- 2 Install your unit in a cool, dry, clean place – away from windows, heat sources, and too much vibration, dust, moisture or cold. Avoid sources of hum (transformers, motors). To prevent fire or electrical shock, do not expose to rain and water.
- 3 Do not operate the unit upside-down. It may overheat, possibly causing damage.
- 4 Never open the cabinet. If a foreign object drops into the set, contact your dealer.
- 5 Do not use force on switches, knobs or cords. When moving the set, first turn the unit off. Then gently disconnect the power plug and the cords connecting to other equipment. Never pull the cord itself.
- 6 Do not attempt to clean the unit with chemical solvents; this might damage the finish. Use a clean, dry cloth.
- 7 Always set the volume control to “-∞” before starting the audio source play: increase the volume gradually to an appropriate level after the play is started.
- 8 To prevent lightning damage, pull out the power cord and remove the antenna cable during an electrical storm.
- 9 Be sure to read the “Troubleshooting” section on common operating errors before concluding that your unit is faulty.
- 10 Do not connect audio equipment to the AC outlets on the rear panel if that equipment requires more power than the outlets are rated to provide.

WARNING: CHEMICAL CONTENT NOTICE!

The solder used in the manufacture of this product contains LEAD. In addition, the electrical/electronic and/or plastic (where applicable) components may also contain traces of chemicals found by the California Health and Welfare Agency (and possibly other entities) to cause cancer and/or birth defects or other reproductive harm.

DO NOT REMOVE ANY ENCLOSURE COMPONENTS!

There are no user serviceable parts inside. All service should be performed by a service representative authorized by Yamaha to perform such service.

IMPORTANT MESSAGE: Yamaha strives to produce products that are both user safe and environmentally “friendly”. We sincerely believe that our products meet these goals. However, in keeping with both the spirit and the letter of various statutes we have included the preceding messages and others in various locations in this manual.

SUPPLIED ACCESSORIES

After unpacking, check that the following parts are contained.

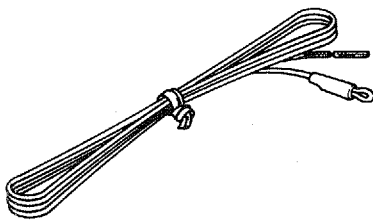

Indoor FM Antenna

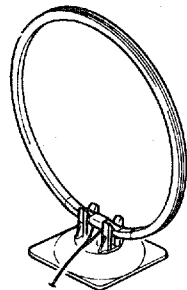

AM Loop Antenna

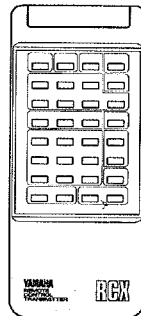

Remote Control Transmitter

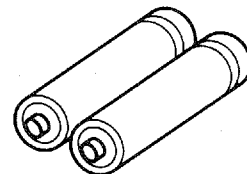

Batteries (size “AAA”, R03)

CONNECTIONS

Before attempting to make any connections to or from this unit, be sure to first switch OFF the power to this unit and to any other components to which connections are being made.

CONNECTIONS WITH OTHER COMPONENTS

When making connections between this unit and other components, be sure all connections are made correctly, that is to say L (left) to L, R (right) to R, "+" to "+" and "-" to "-". Also, refer to the owner's manual for each component to be connected to this unit.

<RX-750>

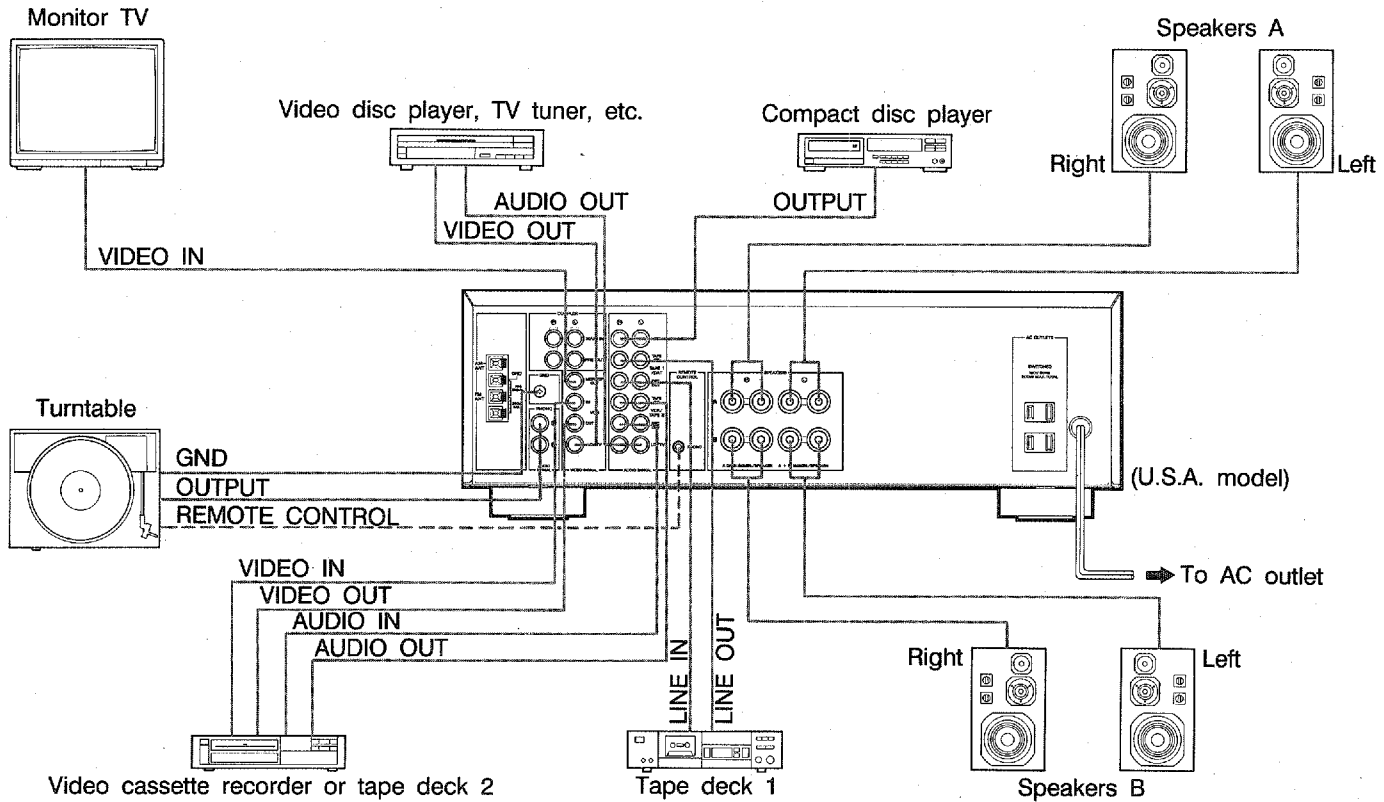

<RX-550>

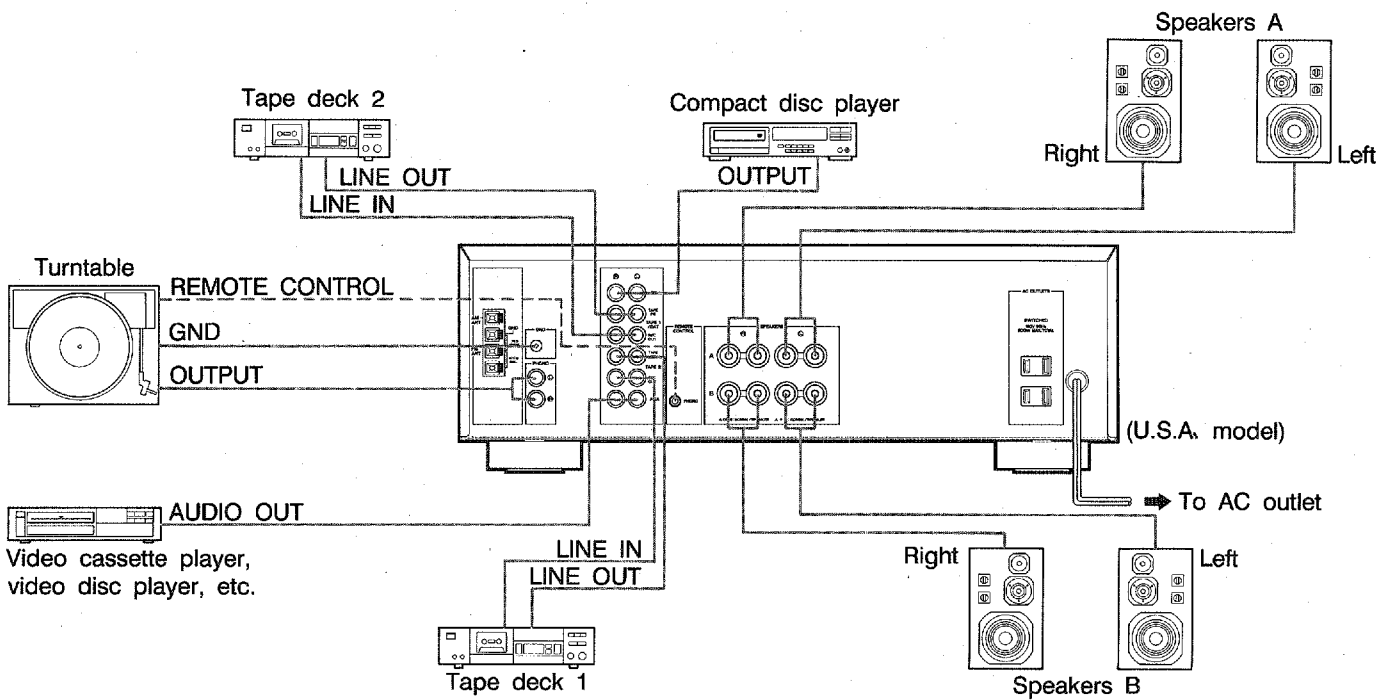

Connecting speaker systems

- One or two speaker systems can be connected to this unit. If you connect only one speaker system, connect it to either **SPEAKERS A** or **B** terminals.
- Use speakers with the specified impedance shown on the rear of this unit.
- **How to Connect:**
Connect the **SPEAKERS** terminals to your speakers with wire of the proper gauge, cut to be as short as possible. If the connections are faulty, no sound will be heard from the speakers. Make sure that the polarity of the speaker wires is correct, that is, + and - markings are observed. If these wires are reversed, the sound will be unnatural and will lack bass. **Do not let the bare speaker wires touch each other or do not let them touch the metal parts of this unit as this could damage this unit and/or speakers.**

Red: positive (+)
Black: negative (-)

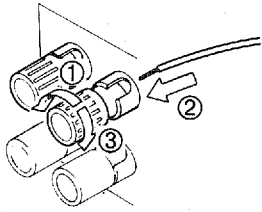

- ① Unscrew the knob.
- ② Insert the bare wire.
- ③ Tighten the knob and secure the wire.

About the accessory terminals

① AC OUTLETS

(U.S.A., Canada, General and Europe models)
.....2 SWITCHED OUTLETS
(Australia and U.K. models) 1 SWITCHED OUTLET
Use these to connect the power cords from your components to this unit.
The power to the **SWITCHED** outlets is controlled by this unit's **POWER** switch. They will supply power to any component whenever this unit is turned on.
The maximum power (total power consumption of components) that can be connected to the **SWITCHED AC OUTLETS** is 200 watts (100 watts for Canada, Australia, U.K. and Europe models).

② REMOTE CONTROL (PHONO) connector

If you have a YAMAHA turntable with the **ERS** mark, connect it to this connector by using the cable provided with the turntable. This connection allows you to control the turntable from the provided remote control transmitter.

③ GND terminal (For turntable use)

Connecting the ground wire of the turntable to this terminal will minimize hum, but in some cases better results may be obtained with the ground wire disconnected.

④ PRE OUT/MAIN IN terminals

<RX-750 only>

Removing the jumper pins enables this unit to independently perform the functions of a control amplifier and a power amplifier. These terminals are for connection of a signal-processing system such as a graphic equalizer or sound processor.
To connect such a unit, remove the jumper pins from the **PRE OUT/MAIN IN** terminals, connect the inputs of that unit to the **PRE OUT** terminals and its outputs to the **MAIN IN** terminals. The Owner's Manual included with the unit may have the detailed informations.
Once the unit is connected, the **VOLUME** control of this unit can be used for overall adjustment of the level of sound.

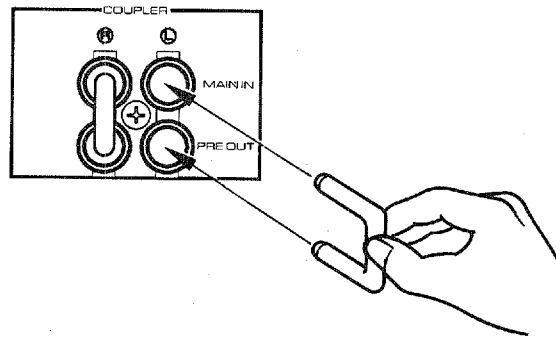

DIFFERENCES BETWEEN RX-750 AND RX-550

This Owner's Manual covers two different models, RX-750 and RX-550. RX-750 is the developed version of RX-550. RX-550 is the simpler type with sufficient functions. In reading this Owner's Manual therefore, the user should note the differences, described below, between the two models.

	RX-750	RX-550
Video signal input/output terminals (for connecting video components)	Provided	Not Provided
PREOUT/MAIN IN terminals	Provided	Not Provided

Because the specifications (such as output power, etc.) are also different, refer to "SPECIFICATIONS" on page 13.

ANTENNA CONNECTIONS

- Each antenna should be connected to the designated terminals correctly, referring to the following figure.
- Both AM and FM indoor antennas are included with this unit. In general, these antennas will probably provide sufficient sensitivity. Furthermore, a properly installed outdoor antenna will give clearer reception than an indoor one. If you experience poor reception quality, an outdoor antenna may result in improvement.

U.S.A., CANADA, U.K., AND GENERAL MODELS

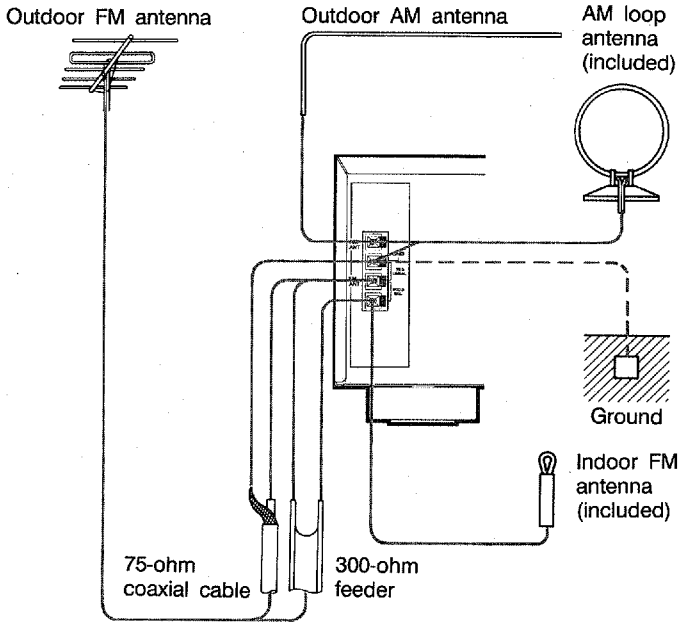

AUSTRALIA AND EUROPE MODELS

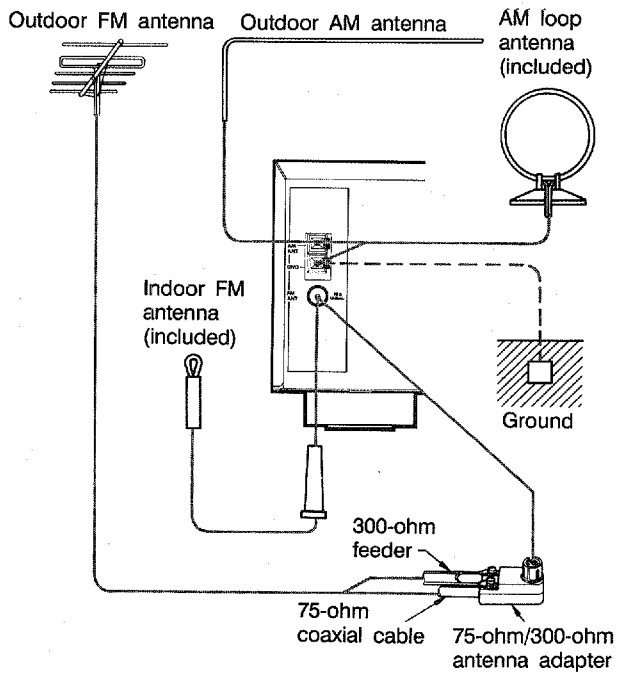

Connecting the AM loop antenna

1

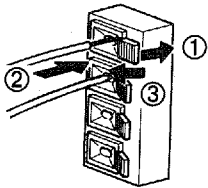

2

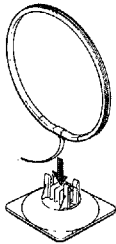

3

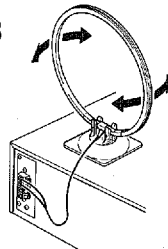

Orient so that the best reception is obtained.

* The antenna may be hung on a wall.

* The AM loop antenna should be kept being connected, even if an outdoor AM antenna is connected to this unit.

GND terminal

For maximum safety and minimum interference, connect the **GND** terminal to a good earth ground if practical. A good earth ground is a metal stake driven into moist earth.

Notes

- When connecting the indoor FM antenna (for Australia and Europe models), make sure that the grooved part of the connector hole is facing downward.
- If you need an outdoor FM antenna to improve FM reception quality, either 300-ohm feeder or coaxial cable may be used. In locations troubled by electrical interference, coaxial cable is preferable.

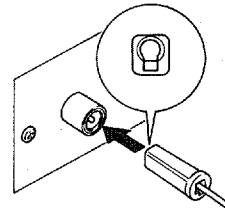

OPERATIONS

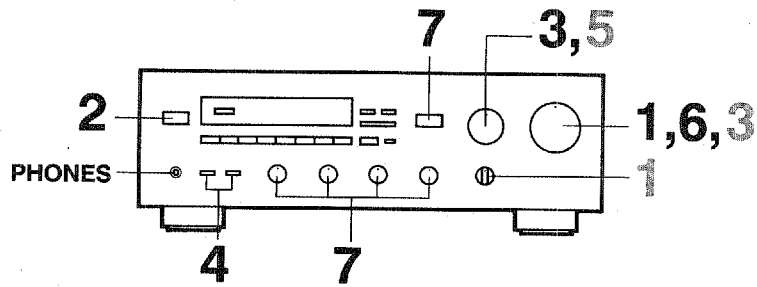

To play a source

- 1**

VOLUME

Set to the "∞" position.
- 2**

POWER
- 3** Select a desired input source.

<RX-750>

<RX-550>
- 4** Select the speaker system to be used by pressing the **SPEAKERS** switches. (Refer to the next page for details.)
- 5** Play the source. (For detailed informations on the tuning operation, refer to the page 9.)
- 6**

VOLUME

Adjust to the desired output level.
- 7** If desired, adjust the **BASS, TREBLE, BALANCE, LOUDNESS** controls and the **PURE DIRECT** switch. (Refer to the next page for details.)

To record a source to tape (or dub from a tape to another)

- 1** Select the source to be recorded.

<RX-750>

<RX-550>
- 2** Play the source.
- 3** Confirm the source by selecting it with the **INPUT** selector and turning up the **VOLUME** control.
- 4** Set the tape deck (or VCR) in the recording mode.
- 5** If your tape deck has three head monitoring capability you can monitor the signal just recorded by selecting the corresponding tape source.

* For details, refer to the manual of the tape deck being used.

Notes

- If you want to enjoy another source while recording, select it with the **INPUT** selector.
- Adjusting the **VOLUME, LOUDNESS, BASS, TREBLE** and **BALANCE** controls during recording has no effect on the material being recorded.

Adjusting the BALANCE control

Adjust the balance of the output volume to the left and right speakers to compensate for sound imbalance caused from the speaker settings or the listening room condition.

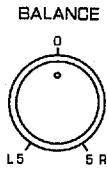

Adjusting the BASS and TREBLE controls

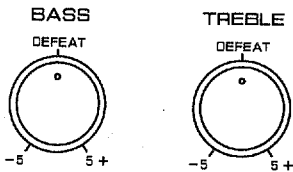

BASS : Turn this clockwise to increase (or counter-clockwise to decrease) the low frequency response.

TREBLE : Turn this clockwise to increase (or counter-clockwise to decrease) the high frequency response.

Selecting the SPEAKER system

Because one or two speaker systems can be connected to this unit, the **SPEAKERS** switches allow you to select speaker system A or B, or both at once.

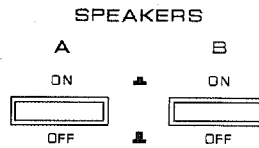

Adjusting the continuous variable LOUDNESS control

This control provides compensation for the human ears' loss of sensitivity to high and low-frequency ranges at low volume. This control is adjustable to retain full tonal range at any volume level.

1 LOUDNESS

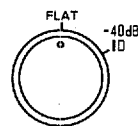

Set to the "FLAT" position.

2

VOLUME

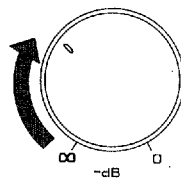

Set to the loudest listening level that you would listen to.

3

LOUDNESS

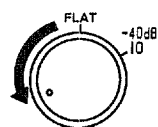

Turn so that the desired volume level can be achieved.

Using the PURE DIRECT switch

You can enjoy purer source sound by setting this switch so that the indicator illuminates. Because, by doing so, the input signal is output directly, bypassing the **BASS**, **TREBLE**, **BALANCE** and **LOUDNESS** controls therefore avoiding any "muddying" caused by circuit routing. Concerning RX-750 only, the **PRE OUT/MAIN IN** terminals are also bypassed.

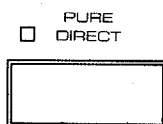

When you listen with headphones

Connect the headphones to the **PHONES** jack. When listening with headphones privately, set both the **SPEAKERS A** and **B** switches to the OFF position.

PHONES

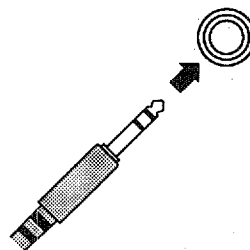

TUNING OPERATIONS

Normally, if station signals are strong and there is no interference, quick automatic-search tuning is possible. However, if signals of the station you want to select are weak, you must tune to it manually.

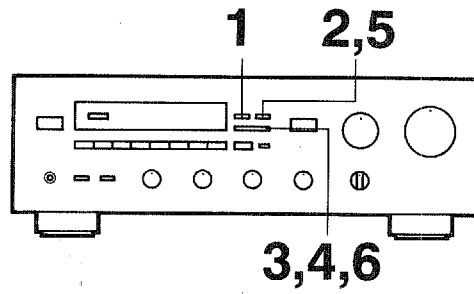

1 Select the reception band (FM or AM) while watching the display.

FM/AM

2

3

4 If the station where tuning search stopped is not the desired one, press again.

5 If the tuning search does not stop at the desired station;

TUNING MODE AUTO/MAN'L MONO

6

* You can tune to the desired station manually.

* To continue tuning search, press and hold the button.

Display Information

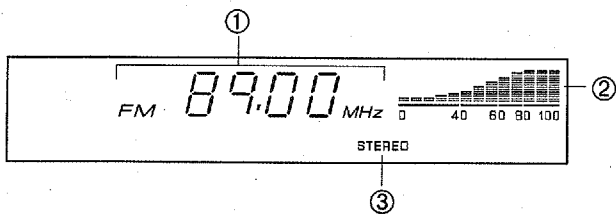

- ① Displays the band and frequency of the received station.
- ② Indicates the signal level of the received station.
- ③ Illuminates when an FM stereo broadcast with sufficient signal strength is received.

Note

If you tune to a FM station manually, it is received in monaural automatically to increase the signal quality.

PRESET TUNING

This unit can store station frequencies (selected by tuning operation) by using preset station buttons. With this function, you can select any desired station by only pressing the corresponding preset station button. Up to 40 stations (8 stations per page) can be programmed.

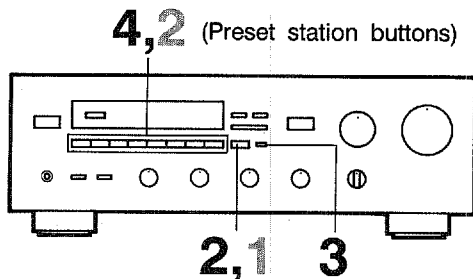

To program stations

- 1 Tune to a desired station.
(Refer to the previous page for tuning procedures.)
- 2 Select a desired page (A – E) of preset station buttons while watching the display.
- 3

Flashes on and off for about 5 seconds.
- 4

Shows the displayed station has been programmed to A1.

* In the same way, program other stations to A2, A3 ... A8.
 * You can program more stations to the preset station buttons at other pages in the same way by selecting other pages in step 2.

To recall a preset station

- 1 Select the page of preset station buttons.
- 2

Select the desired one.

Notes

- In step 4, press a preset station button before "MEMORY" goes off from the display.
- A new setting can be programmed in place of the former one.
- For presets, the setting of the reception mode (stereo or monaural) is stored along with the station frequency.

Memory back-up

The memory back-up circuit prevents the programmed data from being lost even if the power is cut (for timer use or due to temporary power failure). If, however, the power is cut (because of disconnection of the AC power plug etc.) for more than two weeks, the memory may be erased. If so, it can be re-programmed by simply following the PRESET TUNING steps.

REMOTE-CONTROL TRANSMITTER

The remote-control transmitter provided with this unit is designed to control all the most commonly used functions of the unit. If the CD player, turntable, equalizer, and tape deck connected to this unit are YAMAHA components designed for remote control compatibility (components with an **RS** mark), then this remote-control transmitter will also control various functions of each component. Please consult YAMAHA dealer for information on which components are compatible with the remote-control transmitter.

Key Functions

For Receiver Control

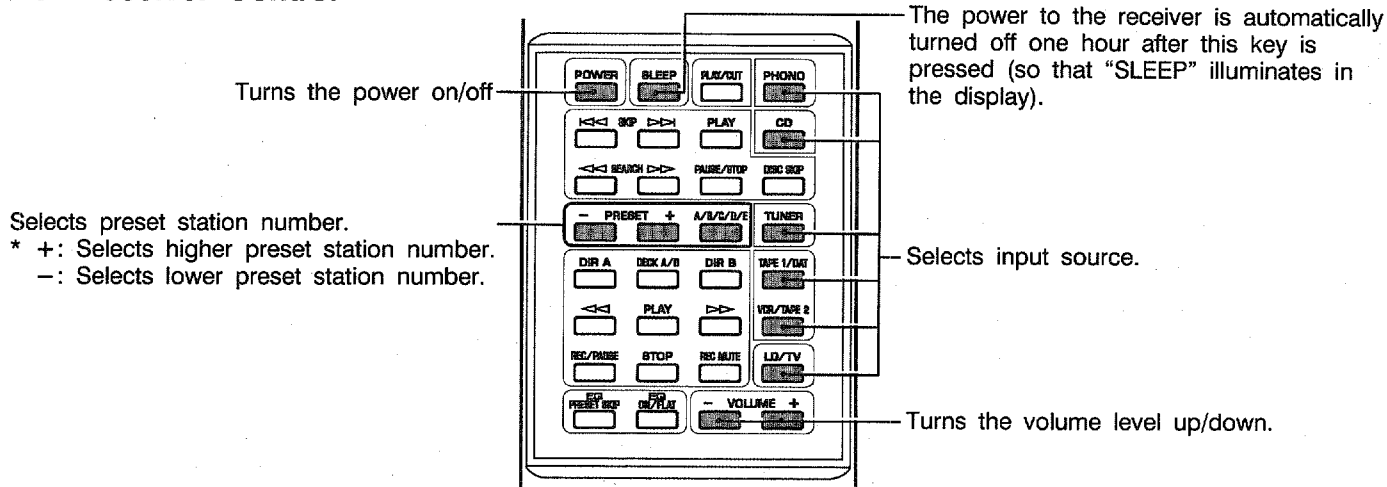

For Other Component Control

Identify the remote-control transmitter keys with your component's keys. If these keys are identical, their function will be the same.
On each key function, refer to the corresponding instruction on your component's manual.

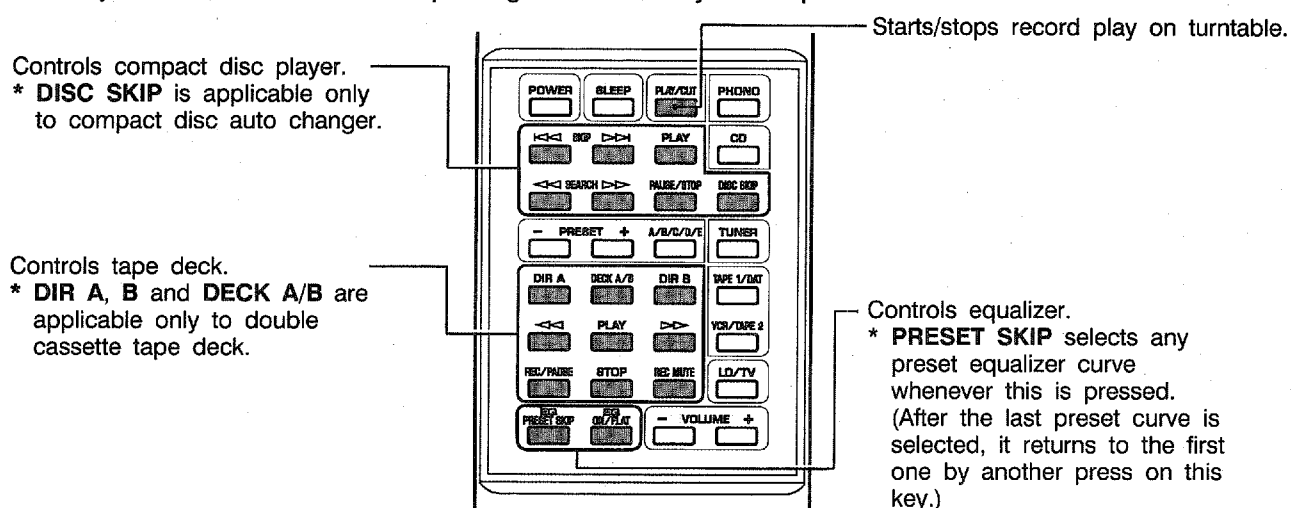

Note

On the remote-control transmitter of RX-550, the **LD/TV** key and **VCR/TAPE 2** key shown on the figures above are respectively replaced by the **AUX** key and **TAPE 2** key.

STANDBY Mode (Europe model only)

While the power is on, pressing the **POWER** key on the remote control transmitter switches the unit to the **STANDBY** mode. (In this mode, the indicator is half illuminated.)

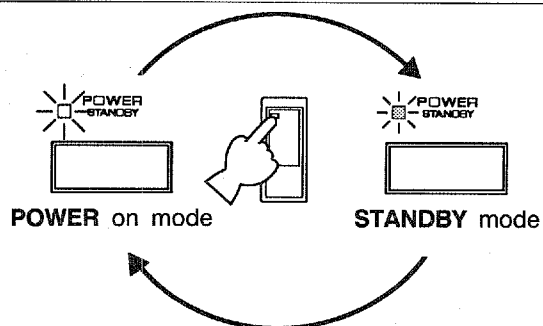

NOTES ABOUT THE REMOTE CONTROL TRANSMITTER

Battery installation

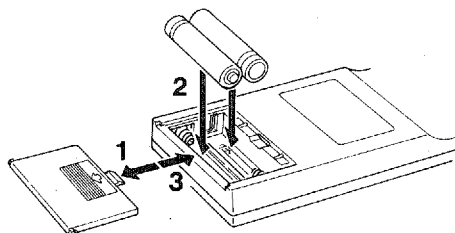

Battery replacement

If the remote-control transmitter must be used closer to the main unit, the batteries are weak. Replace both batteries with new ones.

Notes

- Use only "AAA" (R03) batteries for replacement.
- Be sure the polarities are correct. (See the illustration inside the battery compartment.)
- Remove the batteries if the remote-control transmitter will not be used for an extended period of time.
- If batteries leak, immediately dispose of them. Avoid touching the leaked material or letting it come in contact with clothing, etc. Clean the battery compartment thoroughly before installing new batteries.

Remote-control transmitter operation range

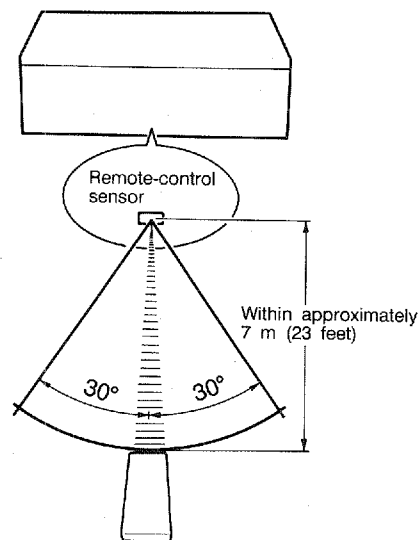

There should be no large obstacles between the remote-control transmitter and the main unit.

TROUBLESHOOTING

If the unit fails to operate normally, check the following points to determine whether the fault can be corrected by the simple measures suggested. If it cannot be corrected, or if the fault is not listed in the SYMPTOM column, disconnect the power cord and contact your dealer or service center for help.

	SYMPTOM	CAUSE	REMEDY
Amplifier	The receiver fails to turn on when the POWER switch is pressed.	Power cord is not plugged in or is not completely inserted.	Firmly plug in the power cord.
	No sound.	Incorrect output cord connections. Incorrect input selection.	Connect cord properly. If the problem persists, the cables may be defective. Set the receiver controls to the correct input selection.
	Using the BASS, TREBLE, BALANCE, and LOUDNESS controls does not affect the tone. The component connected to the PRE OUT/MAIN IN terminals does not function (RX-750 only).	The PURE DIRECT switch is ON.	The PURE DIRECT switch must be switched OFF to use the controls.
	Sound "hums".	Incorrect cord connections.	Firmly connect the audio plugs. If the problem persists, the cord may be defective.
FM	FM stereo reception is noisy.	Because of the characteristics of FM stereo broadcasts, this is limited to cases where the transmitter is far away or the antenna input is poor.	Check the antenna connections. Try using a multiple element FM antenna.
	There is distortion and clear reception cannot be obtained even with a good FM antenna.	There is multipath interference.	Adjust antenna placement to eliminate multipath interference.
	A desired station cannot be tuned in with Auto tuning.	The station is too weak.	Use Manual tuning mode. Use high quality directional FM antenna.
AM	A desired station cannot be tuned in with Auto tuning.	Weak signal or loose antenna connections.	Tighten the AM loop antenna connections and rotate it for best reception. Use Manual tuning mode.
	There are continuous crackling and hissing noises.	These noises result from lightning, fluorescent lamps, motors, thermostats and other electrical equipment.	Use an outdoor antenna and a ground wire. This will help some what but it is difficult to eliminate all noise.
	There are buzzing and whining noises (especially in the evening).	A television set is being used nearby.	Move the television away.

SPECIFICATIONS

AUDIO SECTION

Minimum RMS Output Power per Channel
RX-750
 8 ohms, 20 Hz to 20 kHz, 0.015% THD .. 80 W
 6 ohms, 20 Hz to 20 kHz, 0.03% THD
 [U.S.A. and Canada models] 90 W
RX-550
 8 ohms, 20 Hz to 20 kHz 0.015% THD
 [U.S.A. and Canada models] 60 W
 [Australia, Europe, U.K. and General models]
 55 W
 6 ohms, 20 Hz to 20 kHz 0.03% THD
 [U.S.A. and Canada models] 65 W
 Dynamic Power per Channel (IHF)
 8/6/4/2 ohms
RX-750
 [U.S.A. and Canada models]
 120/150/185/200 W
 [Australia, Europe, U.K. and General models]
 115/130/155/180 W
RX-550
 [U.S.A. and Canada models]
 95/110/130/150 W
 [Australia, Europe, U.K. and General models]
 90/100/120/130 W
 DIN Standard Output Power per Channel
 4 ohms, 1 kHz, 0.7% THD
RX-750
 [Europe model only] 110 W
RX-550
 [Europe model only] 70 W
 IEC Power (1 kHz, 0.01% THD, 8 ohms)
RX-750
 [Europe model only] 85 W
RX-550
 [Europe model only] 65 W
 Power Band Width
RX-750
 8 ohms, 40 W, 0.1% THD 10 Hz to 50 kHz
RX-550
 8 ohms, 30 W, 0.1% THD 10 Hz to 50 kHz
 Damping Factor
 8 ohms, 1 kHz 150 or more
 Input Sensitivity/Impedance
 PHONO 2.5 mV/47 k-ohms
 CD/TAPE/VCR/LD-TV/AUX 150 mV/47 k-ohms
 MAIN IN (RX-750 only) 1 V/14 k-ohms
 Maximum Input Signal Level (1 kHz, 0.01% THD)
 PHONO 115 mV
 Output Level/Impedance
 REC OUT 150 mV/470 ohms
 PRE OUT (RX-750 only) 1 V/470 ohms
 Headphone Jack Rated Output/Impedance
RX-750
 8 ohms, 0.01 % THD 0.5 V/390 ohms
RX-550
 8 ohms, 0.015% THD 0.49 V/330 ohms
 Frequency Response (20 Hz to 20 kHz)
 CD/TAPE/VCR/LD-TV/AUX 0±0.5 dB
 MAIN IN (RX-750 only) 0±0.5 dB
 RIAA Equalization Deviation
 PHONO ±0.3 dB
 Total Harmonic Distortion (20 Hz to 20 kHz)
 PHONO to REC OUT (3 V) 0.007%
RX-750
 CD/TAPE/VCR/LD-TV/AUX to PRE OUT (1V)
 0.005%
 CD/TAPE/VCR/LD-TV/AUX/MAIN IN to SP OUT
 (40 W/8 ohms) 0.008%
RX-550
 CD/TAPE/VCR/AUX to SP OUT
 (30 w/8 ohms) 0.008 %

Intermodulation Distortion
 CD/TAPE/VCR/LD-TV/AUX (Rated Output/8 ohms)
 0.01%
 Signal-to-Noise Ratio (IHF-A Network) (Pure Direct
 Switch: ON)
 PHONO (5 mV Input Shorted) 88 dB
 CD/TAPE/VCR/LD-TV/AUX (Shorted) 109 dB
 Residual Noise (IHF-A Network)
 (Pure Direct Switch: ON) 90 µV
 Channel Separation (1 kHz/10 kHz, Vol. -30 dB)
 PHONO (Input Shorted) 65/50 dB
 CD/TAPE/VCR/LD-TV/AUX
 (Input 5.1 k-ohms Terminated 1 kHz/10 kHz)
 65/50 dB
 Tone Control Characteristics
 BASS: Boost/cut ±10 dB (20 Hz)
 Turnover Frequency 350 Hz
 TREBLE: Boost/cut ±10 dB (20 kHz)
 Turnover Frequency 3.5 kHz
 Continuous Loudness Control -40 dB (1 kHz)
 (Level related equalization)

VIDEO SECTION

Video Input/Output (RX-750 only) ... 1 V/75 ohms

FM SECTION

Tuning Range
 [U.S.A. and Canada and General models]
 87.5 to 107.9 MHz
 [Australia, Europe, U.K. and General models]
 87.5 to 108.0 MHz
 50 dB Quieting Sensitivity (IHF, 75 ohms)
 [Except Europe model]
 Mono 1.55 µV (15.1 dBf)
 Stereo 21 µV (37.7 dBf)
 Usable Sensitivity (75 ohms)
 (30 dB S/N Quieting, 1 kHz, 100% mod.)
 [Except Europe model] 0.8 µV (9.3 dBf)
 DIN, Mono (S/N 26 dB) [Europe model] 0.9 µV
 DIN, Stereo (S/N 46 dB) [Europe model] 24 µV
 Image Response Ratio
 [Except Europe model] 45 dB
 [Europe model] 75 dB
 IF Response Ratio
 [Except Europe model] 80 dB
 [Europe model] 75 dB
 Spurious Response Ratio 70 dB
 AM Suppression Ratio 55 dB
 Capture Ratio 1.5 dB
 Alternate Channel Selectivity
 [Except Europe model] 85 dB
 Selectivity (two signals, 40 kHz Dev.)
 [Europe model] 70 dB
 Signal-to-Noise Ratio
 (IHF) Mono/Stereo
 [Except Europe model] 81/76 dB
 (DIN-weighted, 40 kHz Dev.) Mono/Stereo
 [Europe model] 75/70 dB
 Harmonic Distortion
 Mono/Stereo (1 kHz) 0.1/0.2%
 Mono/Stereo (40 kHz Dev.) 0.1/0.2%
 Stereo Separation (1 kHz)
 [Except Europe model] 50 dB
 [Europe model (40 kHz Dev.)] 50 dB

Frequency Response
 20 Hz to 15 kHz 0 ±1.5 dB

AM SECTION

Tuning Range
 [U.S.A., Canada, Australia, U.K. and General]
 530 to 1,710 kHz
 [Australia, Europe, U.K. and General models]
 531 to 1,611 kHz
 Usable Sensitivity 100 µV/m
 Selectivity 32 dB
 Signal-to-Noise Ratio 50 dB
 Image Response Ratio 40 dB
 Spurious Response Ratio 50 dB
 Harmonic Distortion (400 Hz) 0.3%

AUDIO SECTION
 Output Level/Impedance
 FM (100% mod., 1 kHz)
 [Except Europe model] ... 700 mV/2.9 k-ohms
 [Europe model (40 kHz Dev.)]
 400 mV/3.3 k-ohms
 AM (30% mod., 400 Hz)
 [Except Europe model] ... 200 mV/2.9 k-ohms
 [Europe model]
 150 mV/3.3 k-ohms

GENERAL

Power Supply
 [U.S.A. and Canada models]
 AC 120 V, 60 Hz
 [Australia and U.K. models] AC 240 V, 50 Hz
 [Europe model] AC 230 V, 50 Hz
 [General model]
 AC 110/120/220/240 V, 60/50 Hz
 Power Consumption
RX-750
 [U.S.A. model] 200 W
 [Canada model] 420 W
 [Europe model] 190 W
 [Australia, U.K. and General models] ... 240 W
RX-550
 [U.S.A. model] 150 W
 [Canada model] 310 W
 [Europe model] 130 W
 [Australia, U.K. and General models] ... 170 W
 AC Outlets
 Switched
 [U.S.A. and General model] 200 W max.
 [Canada, Australia, U.K. and Europe models]
 100 W max.
 Dimensions (W x H x D)
 435 x 150 x 388.5 mm
 (17-1/8" x 5-7/8" x 15-1/4")
 Weight
 RX-750 10 kg (22 lbs. 0 oz.)
 RX-550 9 kg (19 lbs. 13 oz.)
 Accessories AM loop antenna
 Indoor FM antenna
 Remote control transmitter
 Batteries

Specifications subject to change without notice.

YAMAHA

YAMAHA ELECTRONICS CORPORATION, USA 6722 ORANGETHORPE AVE., BUENA PARK, CALIF. 90620, U.S.A.
YAMAHA CANADA MUSIC LTD. 135 MILNER AVE., SCARBOROUGH, ONTARIO M1S 3R1, CANADA
YAMAHA ELECTRONIK EUROPA G.m.b.H. SIEMENSSTR. 22-34, D-2084 RELINGEN BEI HAMBURG, F.R. OF GERMANY
YAMAHA ELECTRONIQUE FRANCE S.A. 17 RUE DES CAMPANULES, LOGNES 77321 MARNE LA VALLEE CEDEX 2, FRANCE
YAMAHA ELECTRONICS (UK) LTD. YAMAHA HOUSE, 200 RICKMANSWORTH ROAD WATFORD, HERTS WD1 7JS, ENGLAND
YAMAHA SCANDINAVIA A.B. J A WETTERGRENS GATA 1, BOX 30053, 400 43 VÄSTRA FRÖLUNDA, SWEDEN
YAMAHA MUSIC AUSTRALIA PTY, LTD. 17-33 MARKET ST., SOUTH MELBOURNE, 3205 VIC., AUSTRALIA

YAMAHA CORPORATION
VK56330-0 BWWB 2 , BB ⑧ ⑨ Printed in Japan